

EPA-1500

Network Integrated Amplifier

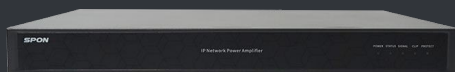

SPON EPA-1500 IP Integrated Amplifier provides multiple connections from a microphone input to a relay output, that's why the amplifier is universally suitable for any size of application. In order to avoid cabling costs and be more flexible, the amplifier is specifically optimised for installation either in a 19" rack or on-site.

SIP

MIC Mute
AdjustableOffline
Ringing

MAIN FEATURES

Design and Amplification

- Compact 1U rack design, both flexible and durable.
- Built-in digital Class-D 500W amplifier suitable for 100V powered loudspeakers.
- Multiple status indicator lights on the front panel for easier maintenance.

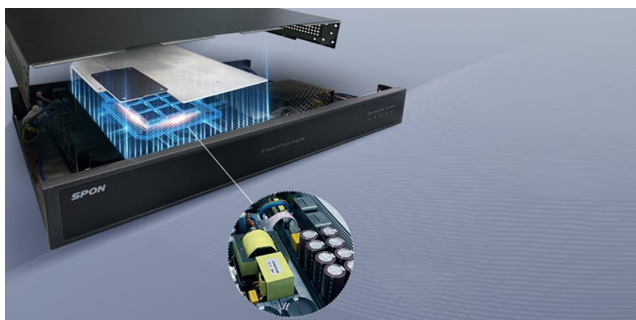

Protection and Storage

- Comprehensive protection circuit for overload, overheating, and lightning.
- Large-capacity storage for uploading and remotely updating timed tasks and alarm files.

Connectivity and Integration

- SIP protocol compatibility for easy integration with mainstream VoIP systems (Yeastar, Asterisk, Cisco, etc.).
- Supports offline broadcasting independently of a server.
- Receives live voice announcements from third-party VoIP systems or SPON's centralized management software.
- Relay I/O port for connecting with third-party fire alarm systems.



SPECIFICATION

Power Parameters

Power Supply: AC 100V-240V, 50/60Hz

Rated Output: 500W

Power Consumption: $\leq 580W$

Audio Parameters

Audio Codec: MP3, PCM, ADPCM, G.711 A-Law, G.711 M-Law, G.729

S/N (Signal-To-Noise) Ratio: $\geq 84dB$

Audio Sampling & Bit Rate: 8kHz~44.1kHz, 16bit, 8kbps~320kbps

THD (Total Harmonic Distortion): $\leq 0.5\%$ At 1kHz, 1/2 Rated Output

Frequency Response: 60Hz~16kHz

Network Parameters

Network I/F: 10BASE-T/100BASE-TX RJ45

Network Protocol: SIP, FTP, HTTP, RTP, TCP/IP, UDP, ARP, ICMP, IGMP.

Configuration Method: Web Interface Or DevConfig Tool.

Accessories

2×5-Pin Pluggable Terminal Block Connector (3.81mm Pitch, AWG 26-16)

1×4-Pin Pluggable Terminal Block Connector (7.62mm Pitch, AWG 28-12)

8×Flat Head Screw

4×3M™ Floor Pad

2×Rack Mounting Bracket

1×Quick Installation Guide

1×Quality Certificate&1×Warranty Card

1×Power Cord

Mechanical&Environment Properties

Mounting Method: 1U Rack-Mounted

Installation Environment: Dry Indoor Locations Only

Operating Temperature: 0°C~+45°C (32°F~113°F)

Storage Temperature: -20°C~+55°C (-4°F~131°F)

Operating Humidity: $\leq 90\%$ RH Non-Condensing

Heat Dissipation: Intelligent Temperature Control, Forced Air Cooling

Protection: Over-Current Protection, Short-Circuit Protection, Overload Protection, Thermal Protection, Lightning Protection, Surge Protection

Front Panel Material: Surface-Treated Steel Plate

Housing Material: Surface-Treated Steel Plate

Color: Black

Product Dimensions: 440×300×44mm⁹

Product Weight: 3.5KG

Packaging: Carton Box

Packed Dimensions: 580×350×140mm

Packed Weight: 4.6KG

Product Warranty: 2 Years Limited

Compliance

CE (EMC Directive 2014/30/EU)

CE (LVD Directive 2014/35/EU)

PORTS DESCRIPTION

[Front Panel]

② **STATUS:**

Green light normally on when online ,red light normally on when offline.

① **POWER:**

Red light normally on when the amplifier is powered on.



③ **SIGNAL:**

No light when there is no signal input ,green light normally on when there is signal input.

⑤ **PROTECT:**

Yellow light normally on when the amplifier is malfunctioning.

④ **CLIP:**

Red light normally on when the amplifier is overloaded.

PORTS DESCRIPTION

[Rear Panel]

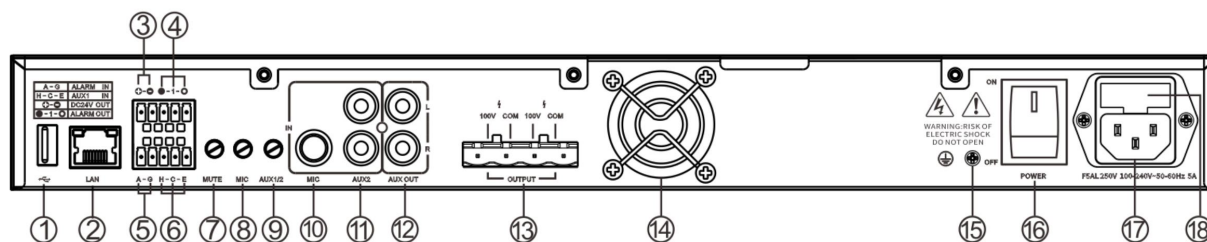

① **USB port** : Reserved.

② **Network port** : To connect to Ethernet switch.

③ **DC 24V Power Relay Output** :
2-Pin pluggable terminal block (3.81mm Pitch, AWG 26-16), normally open (NO) dry contact with DC 24V power output.

④ **Relay Output** :
3-Pin pluggable terminal block (3.81mm Pitch, AWG 26-16), normally open (NO) or normally closed (NC) dry contact

⑤ **Relay Input** :
2-Pin pluggable terminal block (3.81mm Pitch, AWG 26-16), normally open (NO) dry contact;

⑥ **Aux Input 01**:
3-Pin pluggable terminal block(3.81mm Pitch, AWG 26-16) (Balanced, Sensitivity/ Impedance: 500mV/10k Ω);

⑦ **MUTE Knob**:
MUTE depth adjustment knob, when the MIC input signals, it'll automatically MUTE AUX1 and AUX2, clockwise rotation will increase the MUTE depth, anticlockwise rotation will decrease the MUTE depth;

⑧ **MIC Knob** :
Adjust the MIC input volume, clockwise rotation will increase the volume, anticlockwise rotation will decrease the volume;

⑨ **AUX1/2 Knob** :
Adjust the Line input volume ,clockwise rotation will increase the volume, anticlockwise rotation will decrease the volume.

⑩ **Mic Input**:
1/4-inch (6.35mm) TRS Jack (Unbalanced, Sensitivity/Impedance: 100mV/600 Ω)

⑪ **Aux Input 02**:
Dual RCA Jacks (Unbalanced, Sensitivity/ Impedance: 500mV/10k Ω)

⑫ **Aux Output**:
Dual RCA Jacks.

⑬ **Speaker Output 01/02 (100V)**:
2-Pin Pluggable Terminal Block (7.62mm Pitch, AWG 28-12), connecting and driving 100V constant-voltage passive speakers;

⑭ **Cooling Fan**

⑮ **Ground Terminal**

⑯ **Power Switch**

⑰ **Power Input Interface**

⑱ **Insurance Block**

CONNECTION DIAGRAM

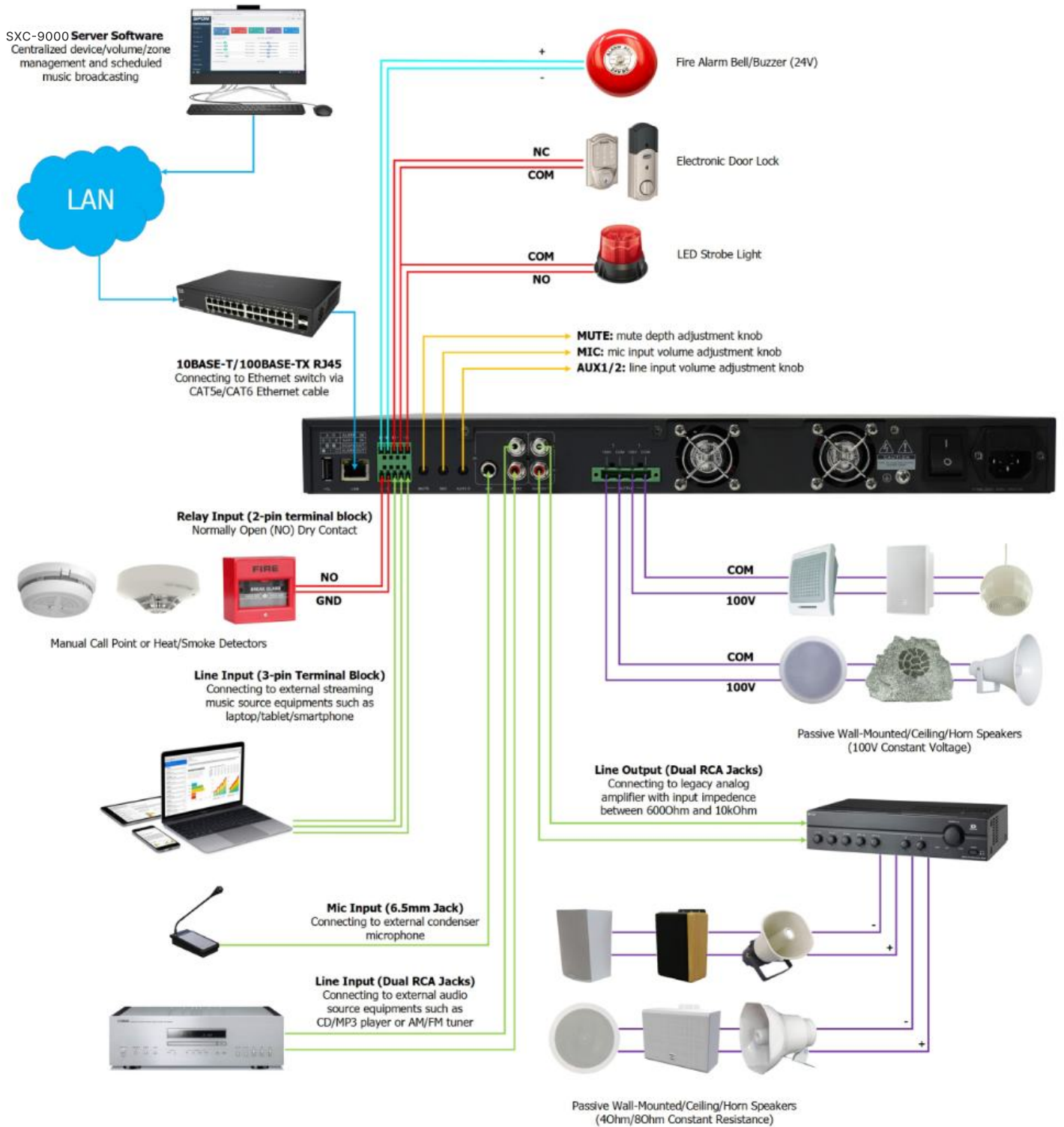

APPLICATION

Application 1

IP Integrated Amplifier EPA-1500 can receive real-time voice announcement initiated by the 3-rd party VOIP telephone、SPON IP paging microphone/APP(Windows、Android/IOS),etc. With built-in amplifier and line output interface, the voice can be transmitted to external passive speaker for amplification.

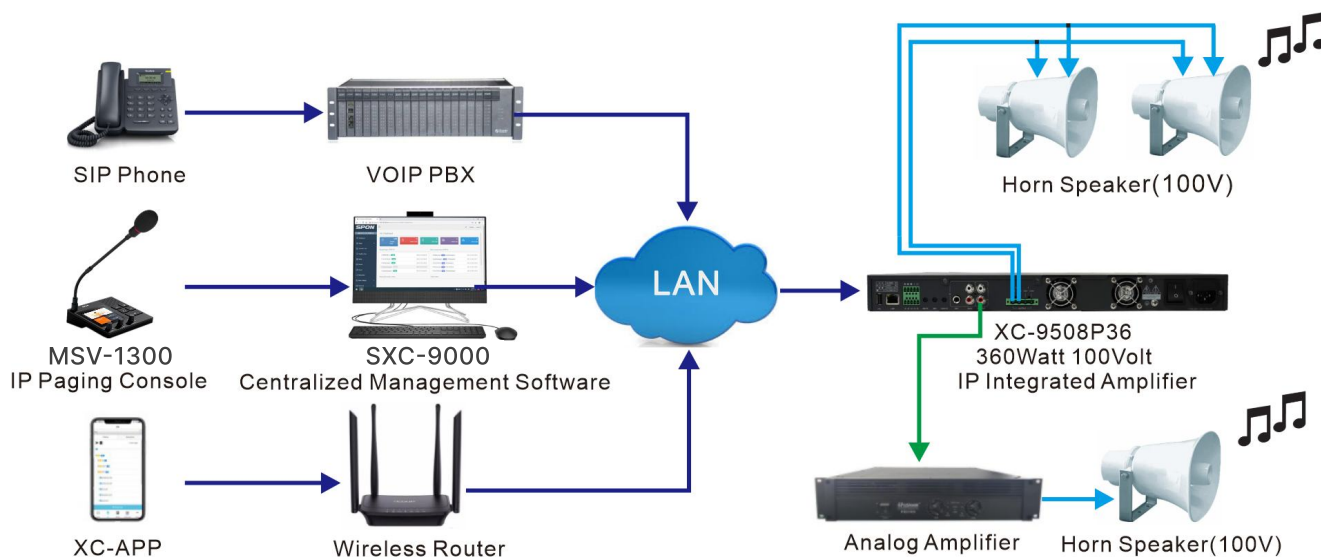

Application 2

The IP paging amplifier EPA-1500 support to receive offline timed broadcasting , the offline timed tasks need to be pushed to the FTP of EPA-1500, when the windwos crashed , the system can normally work.

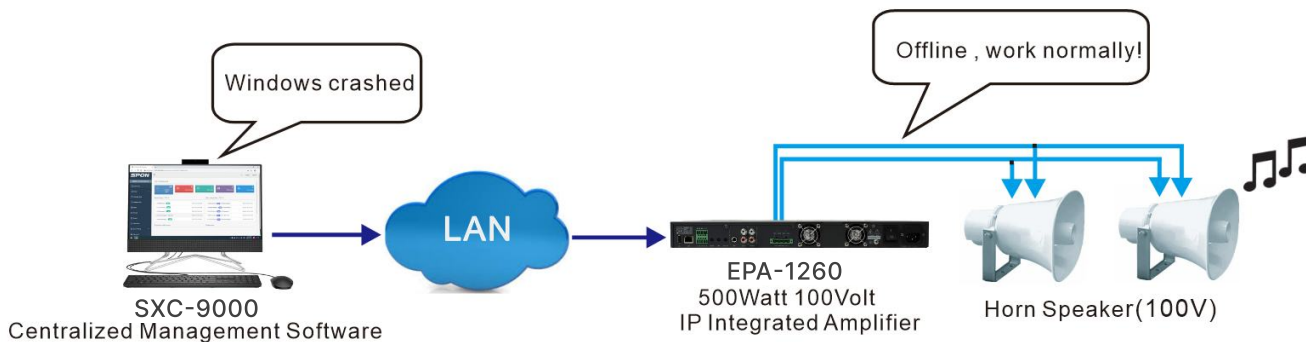

APPLICATION

Application 3

The IP paging amplifier EPA-1500 support to automatic broadcast alarm tone when receiving relay input signal from the 3-rd party system (For example ,IP camera of surveillance system 、 Emergence button of Fire alarm system) , the alarm tone need to be pre-uploaded to the FTP of EPA-1500.

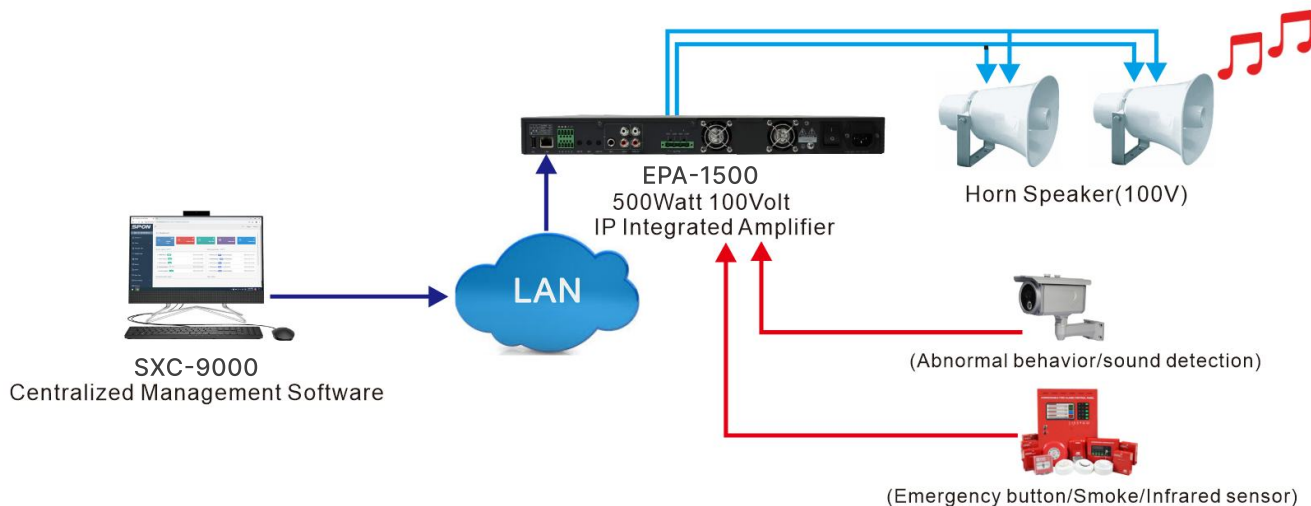

DIMENSION DRAWING

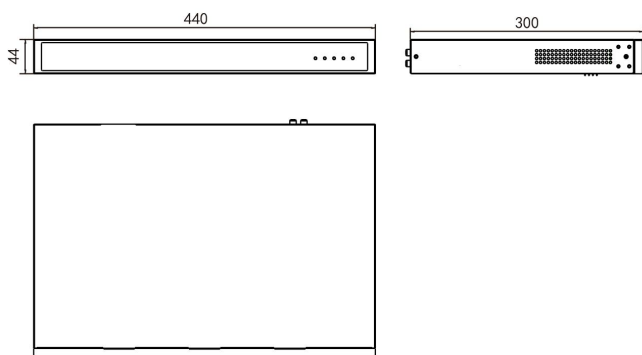

IP paging amplifier EPA-1500 in rack-mounted installation with 4pcs of white washers head screws (M3*5). Please refer to the following dimension diagram to put device in suitable cabinet wall according to the following appearance installation dimension drawing.

CASE



SPON SPON Communications Co., LTD

Address: No.70, Nantang Road, High-Tech Zone, Changsha, China.

Mobile: +86 138 7314 3517

Email: inquiry@sponcomm.com **Tel:** +86 731 8557 0190



www.sponcomm.com